

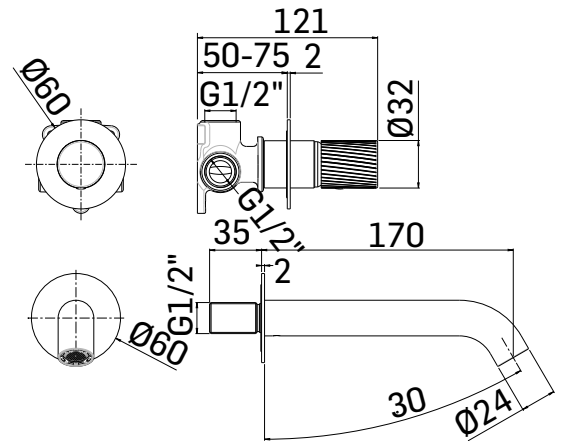

RUBINETTERIA

SERIE/RANGE: GIULIA

ARTICOLO/ITEM: 75864



## DESCRIZIONE PRODOTTO/PRODUCT DESCRIPTION:

Miscelatore monocomando da incasso per lavabo, in acciaio inox, composto da parte grezza, parte esterna di finitura e bocca di erogazione

Concealed single lever basin mixer, made of stainless steel, composed by assembly components, external components and wall-mounted spout

## DATI COSTRUTTIVI/TECHNICAL INFORMATION:

## FINITURE/FINISHING:

75861	CROMO/CHROME
75862	ACCIAIO SPAZZOLATO/BRUSHED STAINLESS STEEL
75863	NERO OPACO/MATT BLACK
75864	OTTONE SPAZZOLATO/BRUSHED BRASS

## CARATTERISTICHE FUNZIONALI/TECHNICAL FEATURES:

Pressione minima di esercizio/Minimum working pressure	0,5 bar
Pressione di esercizio consigliata/Recommended working pressure:	1-5 bar
Temperatura max acqua calda/Maximum temperature	80° C
Temperatura max acqua calda consigliata/Recommended maximum temperature	65° C